

Compose BoxPro product series are professional software tailored for packaging and label printing. It comes in a suite of three outstanding applications which is ideal for every packaging projects or folding paper design from initial design, project-data storage, dimensional drawing, layout imposition, driving cutting machine to 3 dimensional modeling. They included BoxProCentral, BoxProViewer, and BoxProIllustrator.



Production Family

Designed to streamline
prepress production

BoxProCentral

BoxProViewer

BoxProIllustrator

Highlights

BoxProCentral

- Come with a set of International Standard Box-Data Library
- Package Assistant helps to create box with ease and accuracy
- Direct export Illustrator files for design
- Support most standard file format for import and export
- Auto or refining Manual Layout Imposition
- Server controlled data administration
- Support most popular cutting machines and plotters
- Easy to define cutting direction, Zipper Line and Lead Line

BoxProViewer

- 3 Dimensional viewing capability
- Simulate different types of paper, such as corrugated or carton paper, or different thickness of paper in the 3D view.
- Easy to define cut lines, crease lines and folding sequences for folding preview inside Illustrator
- Export options for print or web viewing
- Cost saving in producing the dummy artwork
- Support 3D still or movie preview in QuickTime format for product demonstration or visual folding instruction

BoxProIllustrator

- Take advantage of Illustrator for imposition with graphic design
- Improve efficiency in packaging design or envelopes
- Manual or automatic imposition schemes for choices
- Simple estimation on material consumption to facilitate production planning and cost saving
- Automatic serial number generation

Introduction

Compose BoxPro product series are a professional software tailored for packaging and label printing. It comes in a suite of three outstanding applications including BoxProCentral, BoxProViewer and BoxProIllustrator.

BoxProCentral is a professional CAD software exclusively use for packaging design, bundled with an extendable Box-Data Library with a collection of over 400 styles of box. It caters for the various stages of the box layout design, dimensional drawing, overlap, imposition to final output of driving cutting machines.

BoxProViewer and BoxProIllustrator are perfect plugins for Illustrator for 3D modeling and layout design or any other folding paper artwork. User can export 3D job image in different resolution as well as 3D job preview in a FREE movie player to their clients for web viewing.



compose

An Open Future

www.compose.com.hk www.compose.co.uk www.composeusa.com

Features and Benefits

Extendable Box-Data Library

Compose BoxProCentral comes with over 400 practical box data library selected under European FEFCO and Japanese standard. Operators can pick from over 60 patterns of box and changing them into boxes of desired shapes and sizes by varying just a few parameters. Also users can pick box parts, such as flap or lid to add to the design to build up their own box-data library.

Easy To Create New Box

Besides modifying templates from Box-Data Library, user can also use Package Assist to create new boxes.

Manual & Auto Layout Imposition

BoxProCentral provides comprehensive imposition feature for package application: paper boards (determine numbers of imposition from each standard sizes), corrugated packages (determine required size of corrugated packages from numbers of imposition) and C-Type (box with lid). On the other hand, necessary informations are also provided for quotes such as blade length, contour length, ruling length etc.

Select from useful box-data library and modify to your desired box design.

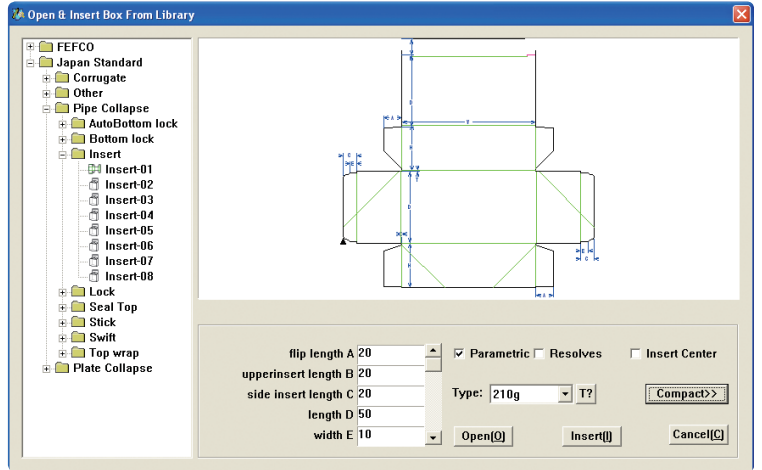

Use Package Assist to create your desired box design.

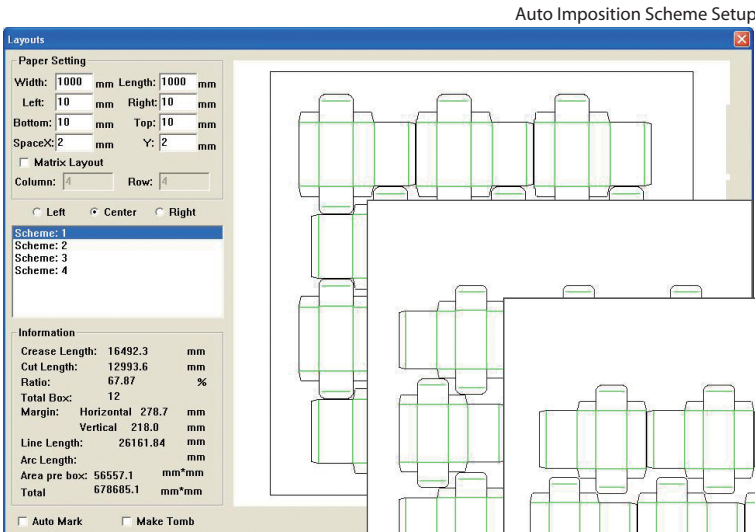
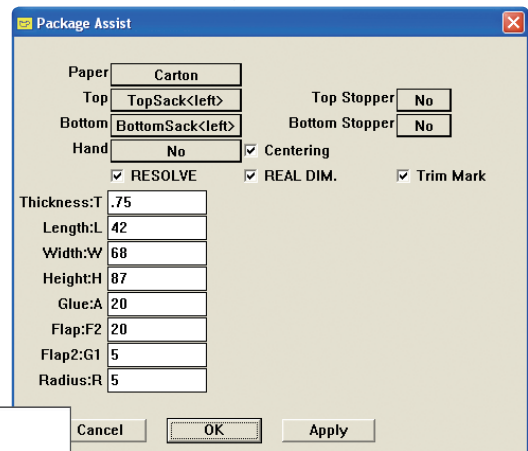

Manual Step & Repeat Imposition Setup

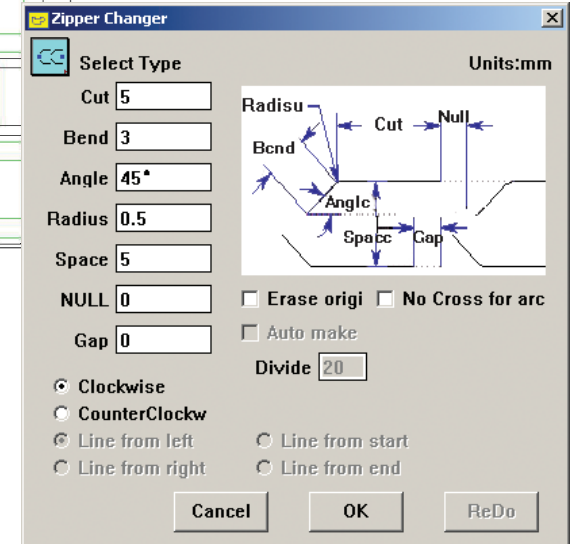
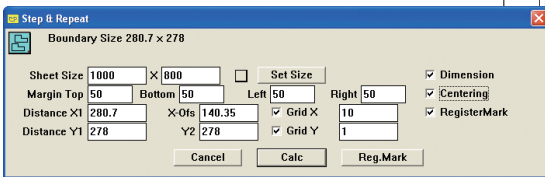

Easy Line Editing

BoxProCentral provides easy line editing feature for user to change any lines or arcs into zipper line and lead line. For die-making, it is also very simple to change the creasing lines into crease marks.

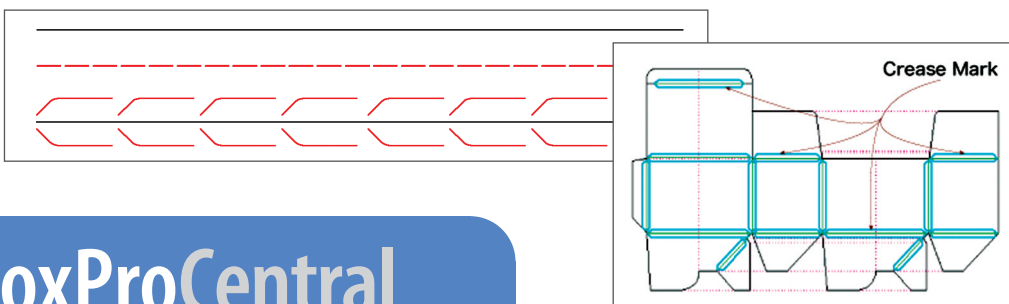

BoxProViewer

BoxProViewer and BoxProIllustrator works as a plug-in in Illustrator

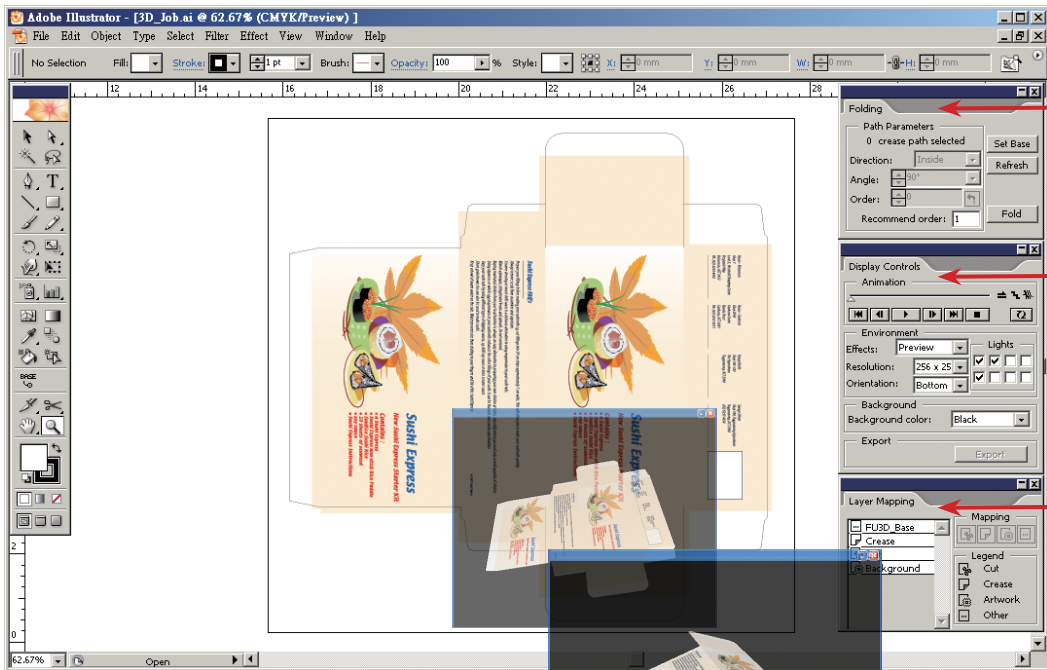

Folding Tools enables user to set the parameters of the folding direction, angle and order.

Display Controls Tools enables user to trace and set the parameters of the effects, resolution, orientation, background and lighting of the 3D environment.

Layer Mapping Tools enables user to map the layer setting in the file.

BoxProViewer

BoxProViewer works as a plug-in for Illustrator (Version 8, 9, 10 & CS), taking full advantages of Illustrator from graphics placement to 3D preview.

Advanced Export Feature

BoxProViewer offers various export options for user to share their design with their valued customer such as the standard express export at 72 dpi for web, custom export option at 360 dpi image for printing or export in QuickTime movie which is perfect for multimedia presentations or a web gallery of 3D designs. User can take ultimate control by exporting a BoxProViewer model files with different display settings such as lighting effect, resolution, rotate orientation and background color to give your clients the realistic view of the finished models in advance.



Enhanced Position Palette

With enhanced position palette, user can quickly save different preview positions such as zoom, rotation, or even steps in the folding process. Perfect for standardizing display angles across a project or for each member of your team. Better yet, design once and use everywhere: with the position palette, it's easy to save standard positions for your print brochures, web pages, promotional coupons and much more.

OpenGL® 3D Technology

BoxProViewer uses the power of OpenGL®, the industry standard for 3D imaging, everything expectation from 3D graphics: free rotation, flexible re-sizing and excellent rendering. With impressive display settings you can preview your design as a transparent package, in different standard paper texture or fully rendered object.

Also suitable for generate 3D model for label printing

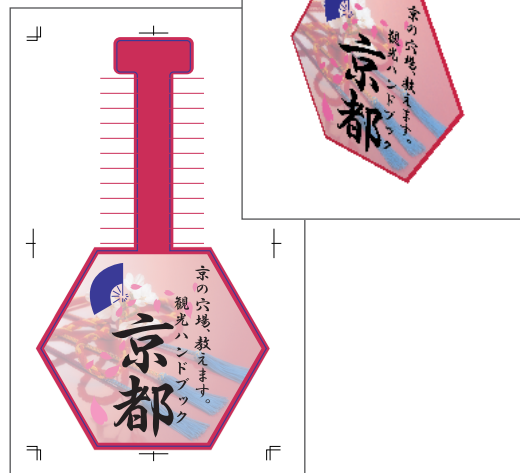

BoxProIllustrator

BoxProIllustrator

BoxProIllustrator works as a plug-in for Illustrator (Version 8, 9, 10 & CS), taking full advantages of Illustrator from graphics placement to layout imposition.

Manual or Auto-layout Imposition

BoxProIllustrator provides easy Auto Layout Setting tool for user to choose from different step-and-repeat imposition solution. BoxProIllustrator will automatically calculate the possible solutions for all selected printing presses. It will also calculate the number of sheets required for each solution to print the requested quantity, allowing users to easily choose the most efficient solution. User can also fine tune the imposition manually by entering the number of rows and columns and minimum distance between dies to generate optimal imposition result.

Marks and Tombs

Automatically add serial number with prefix and separator and place them at specific location on the die. User can also add selected crop and registration marks to the layout and configure the width and height of each mark.

Higher Efficiency in Layout Design

BoxProIllustrator offers high efficiency for designer or prepress operator to generate a press ready layout design for printing.

Higher efficient in layout design for printing

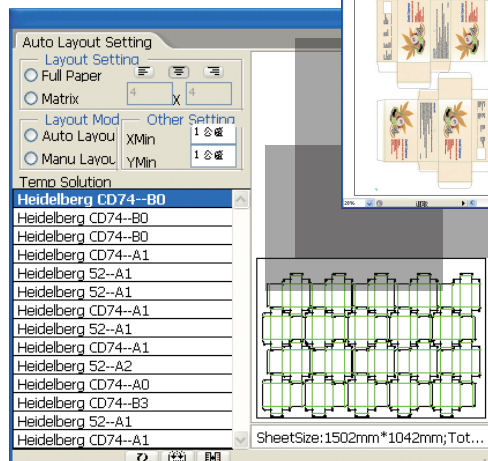
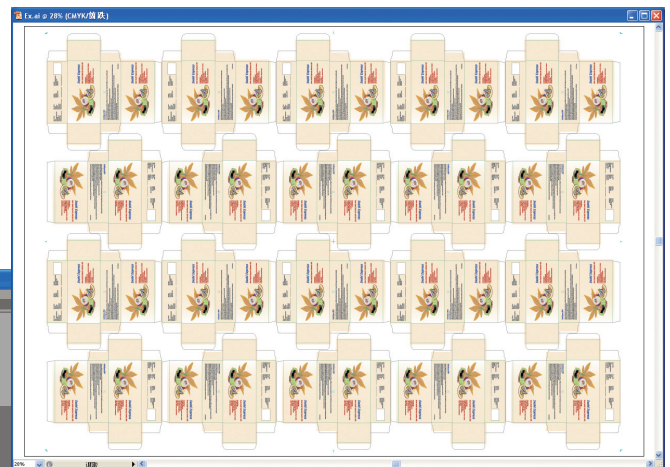

Auto Layout Setting Tools in BoxProIllustrator

Manu Adjust Tools in BoxProIllustrator

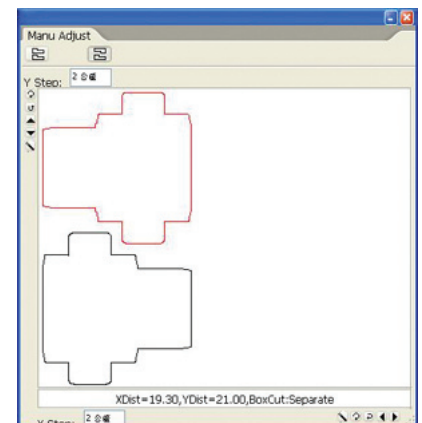

System requirements

BoxProViewer and BoxProIllustrator

OS: Windows 2000, XP Professional, 2003 Server
CPU: Intel Pentium processor or later
Memory: 2GB RAM
Illustrator 8, 9, 10 or CS
Graphics Card: supporting OpenGL® 1.1 or later

BoxProCentral

OS: Windows 2000, XP Professional, 2003 Server
CPU: Intel Pentium processor or later
Memory: 2GB RAM
Illustrator 8, 9, 10 or CS
Graphics Card: supporting OpenGL® 1.1 or later



Copyright © 2008 Compose. All rights reserved.
Compose logo is the trademark of Compose System Limited and its subsidiaries.
All other brands and product names are trademarks or registered trademarks of their respective owners.
All specifications and price changes are subject to change without notice.
Compose cannot accept liability for any loss or damage arising from the use of information or particulars in this document.